

10057726

BRECOFLEX® - Zahnriemen

25 T5/215 mm

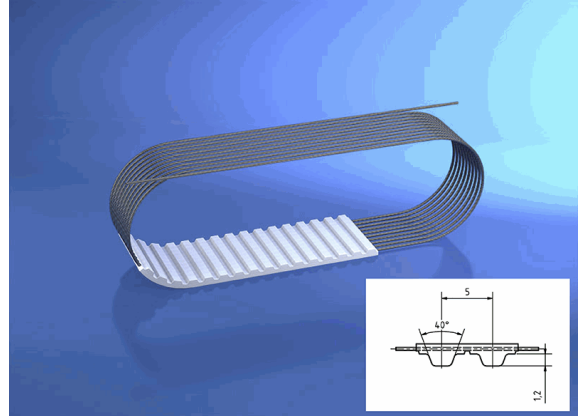

23.02.2023 09:05:20

Technical Data

Weight	0,011 kg per piece
belt type	standard
eCl@ss 6.2	23-17-02-05
is standard	yes
material type	TPUST1
pitch length	215,00 millimeter
polyamide tissue	ohne
tension member belt	standard
tooth profile	T 5
width	25,00 millimeter

Conformity

Commodity code	39269097
China-RoHS	n/a
Dual-Use	no
REACH regulation	2006/1907/EG (REACH)
RoHS directive	2011/65/EU (RoHS II)
RoHS directive (III)	2015/863/EC (RoHS III)



10057726

BRECOFLEX® - Zahnriemen

25 T5/215 mm



23.02.2023 09:05:20

* n/s - not specified
n/a - not applicable

**** technical specifications/ conformities**

This data sheet has been created with great care and all information has been checked for correctness. However, no liability is accepted for any incorrect or incomplete information. Product images and drawings are for illustration purposes only and may vary in detail. Due to the constant further development of the products, changes in the product range and the product design are reserved! Performance and consumption data as well as descriptions may therefore differ. The use of the products is beyond our control and is therefore not our area of responsibility.

