

**10059659**

**BRECOFLEX® - Zahnriemen**

**75 T5/1100 mm, PAZ**

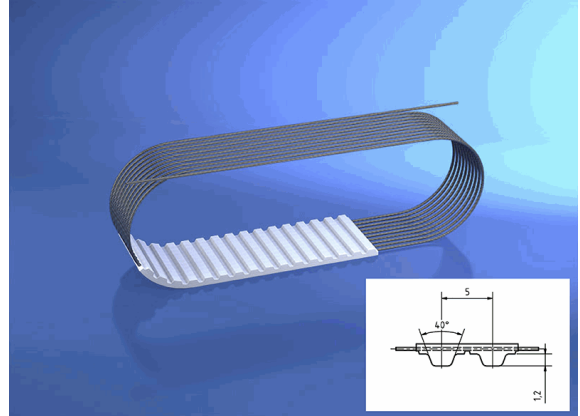

02.02.2023 15:37:19

**Technical Data**

Weight	0,179 kg per piece
belt type	standard
eCl@ss 6.2	23-17-02-05
is standard	yes
material type	TPUST1
pitch length	1.100,00 millimeter
polyamide tissue	PAZ
tension member belt	standard
tooth profile	T 5
width	75,00 millimeter

**Conformity**

Commodity code	39269097
China-RoHS	n/a
Dual-Use	no
REACH regulation	2006/1907/EG (REACH)
RoHS directive	2011/65/EU (RoHS II)
RoHS directive (III)	2015/863/EC (RoHS III)



**10059659**

**BRECOFLEX® - Zahnriemen**

**75 T5/1100 mm, PAZ**

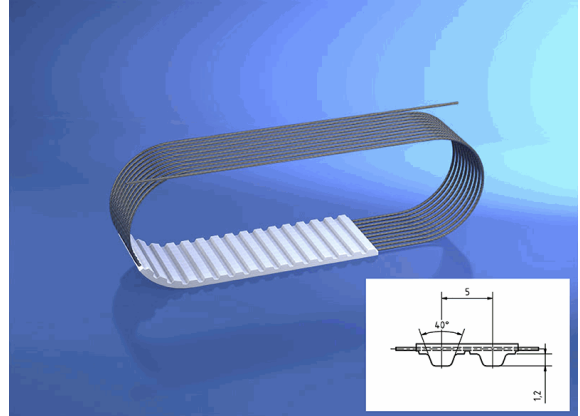

02.02.2023 15:37:19

\* n/s - not specified  
n/a - not applicable

**\*\* technical specifications/ conformities**

This data sheet has been created with great care and all information has been checked for correctness. However, no liability is accepted for any incorrect or incomplete information. Product images and drawings are for illustration purposes only and may vary in detail. Due to the constant further development of the products, changes in the product range and the product design are reserved! Performance and consumption data as well as descriptions may therefore differ. The use of the products is beyond our control and is therefore not our area of responsibility.

